

# WABCO



# MOTSAN GASKET



# IVECO

# MOTSAN GASKET



Motor/Engine	Cm <sup>3</sup>	HP	Ø
			MM

DIESEL

## IVECO

# IVECO IVECO

OEM	Description Of Goods	Mat.	Qty.	Reference
-----	----------------------	------	------	-----------

## AIR COMPRESSOR SET GASKET

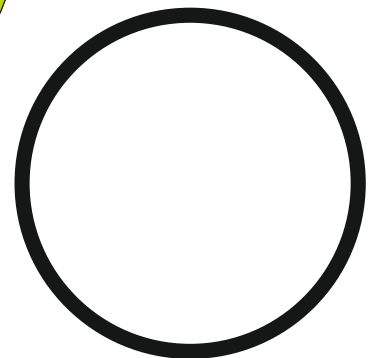
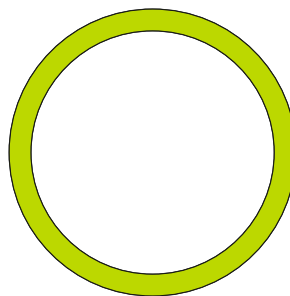
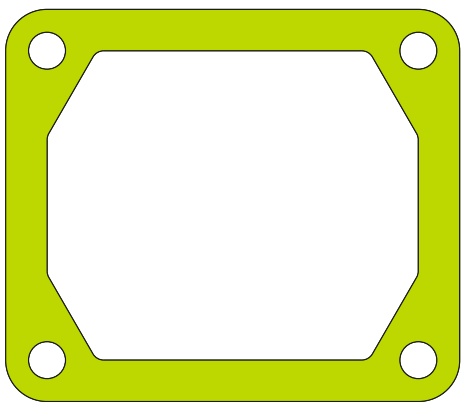
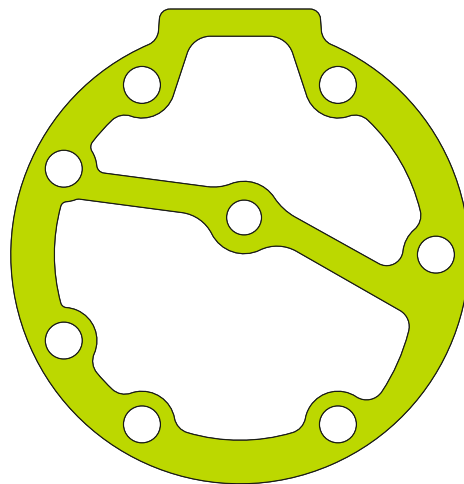
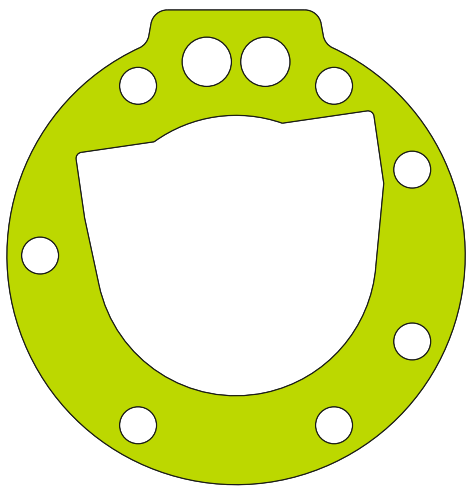

504.154

# MAN

## MOTSAN GASKET

Motor/Engine	Cm <sup>3</sup>	HP	Ø
			90 MM
DIESEL			



MAN

OEM	Description Of Goods	Mat.	Qty.	Reference
-----	----------------------	------	------	-----------

### AIR COMPRESSOR SET GASKET

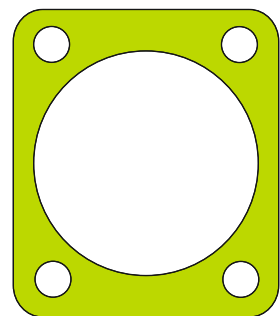
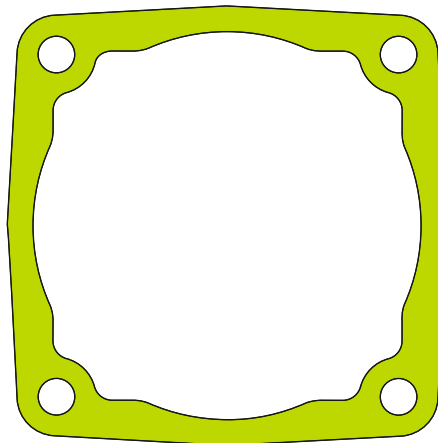
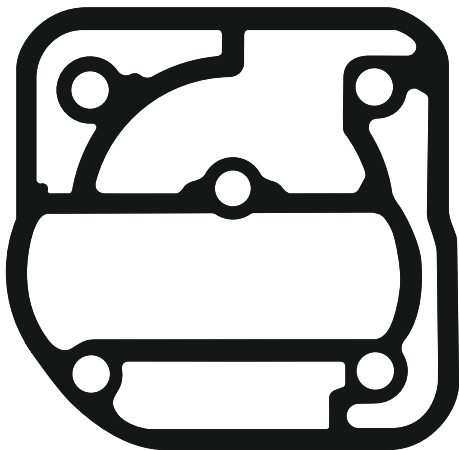
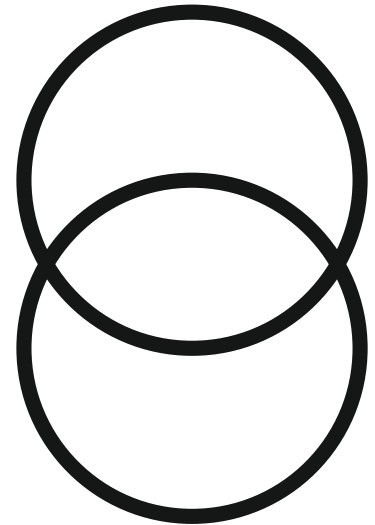
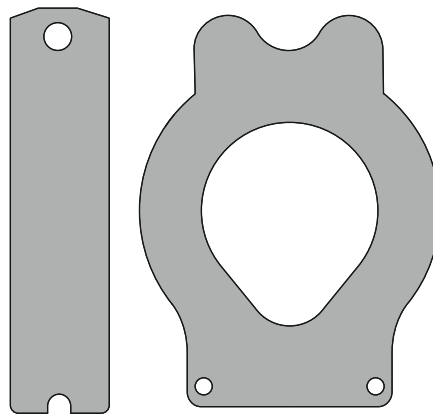
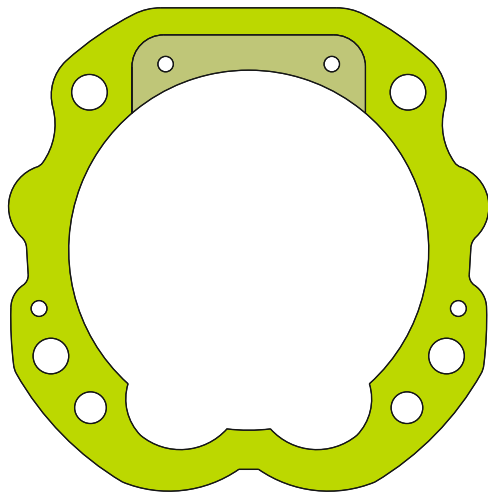

504.080

# MAN

## MOTSAN GASKET

Motor/Engine	Cm <sup>3</sup>	HP	Ø
19.190			88 MM
DIESEL			



MAN TRAC-BUSS  
19.190-5.90 HN

OEM	Description Of Goods	Mat.	Qty.	Reference
-----	----------------------	------	------	-----------

### AIR COMPRESSOR SET GASKET

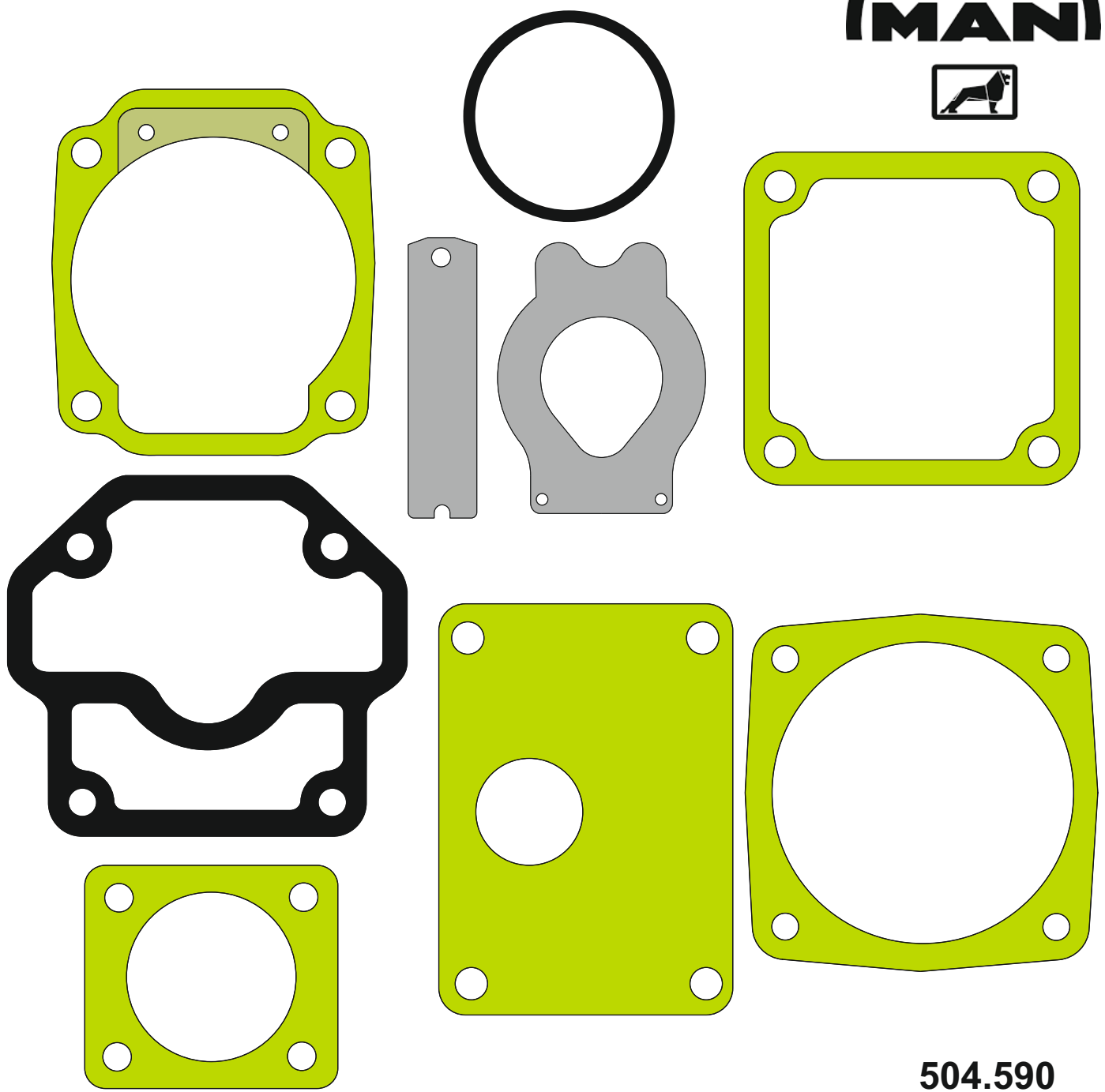

504.590

**DAF&IVECO**

**MOTSAN GASKET**



**DAF  
IVECO**

Motor/Engine	Cm <sup>3</sup>	HP	Ø
			75 MM
<b>DIESEL</b>			



OEM	Description Of Goods	Mat.	Qty.	Reference
-----	----------------------	------	------	-----------

**AIR COMPRESSOR SET GASKET** 

**IVECO**

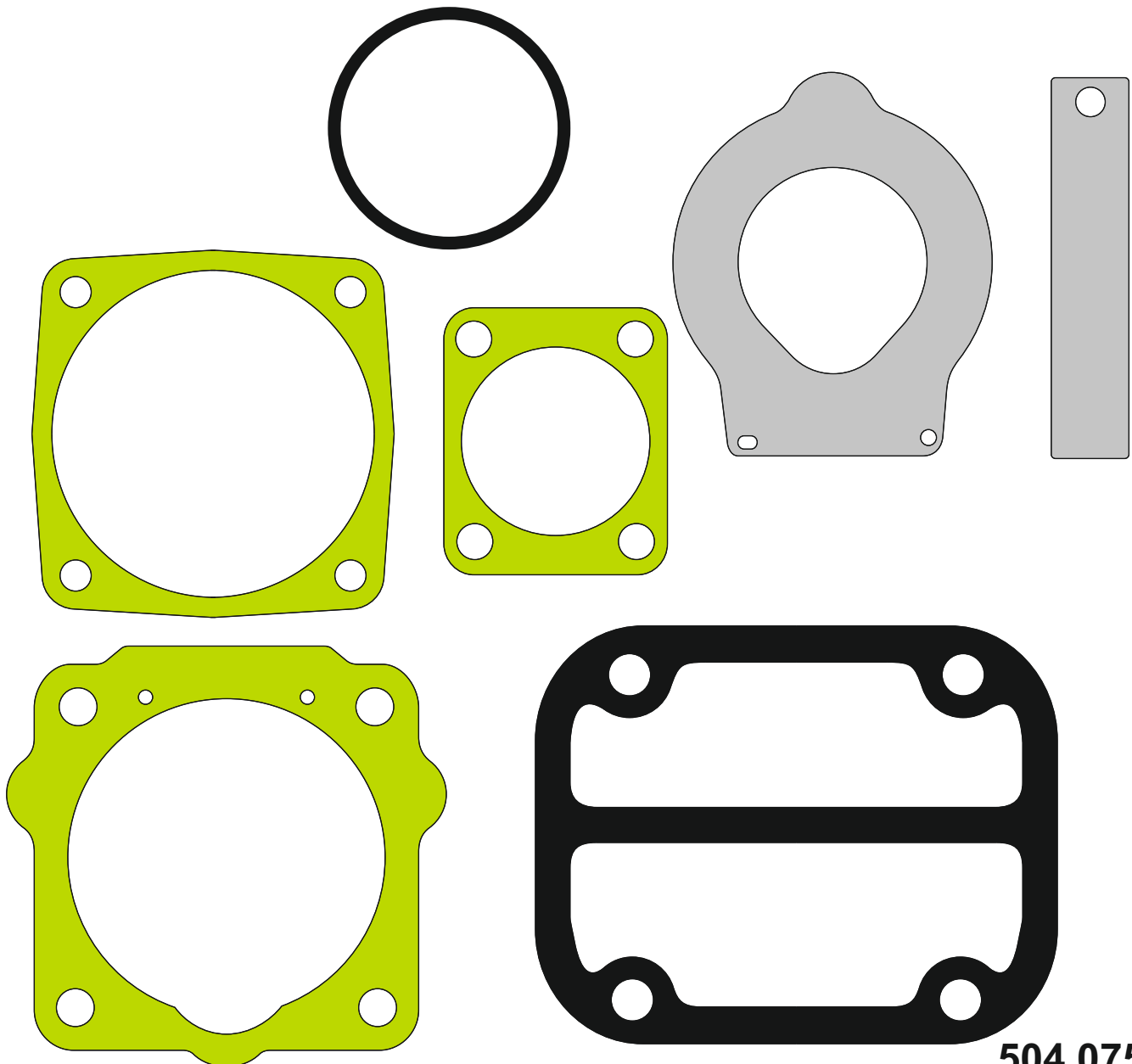

**504.075**

# MERCEDES

# MOTSAN GASKET

Motor/Engine	Cm <sup>3</sup>	HP	Ø
			90 MM
<b>DIESEL</b>			



**MERCEDES-BENZ**  
**OM 355-346**

OEM	Description Of Goods	Mat.	Qty.	Reference
-----	----------------------	------	------	-----------



## AIR COMPRESSOR SET GASKET

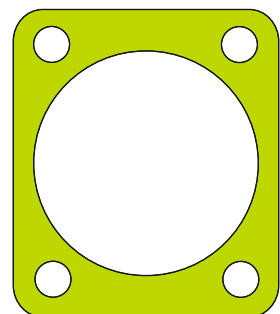
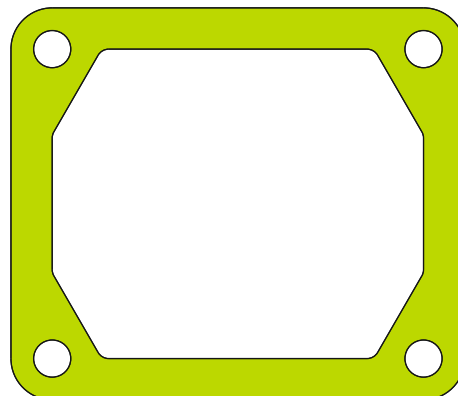
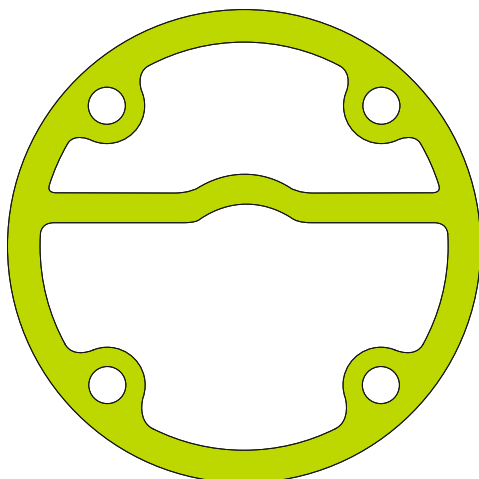
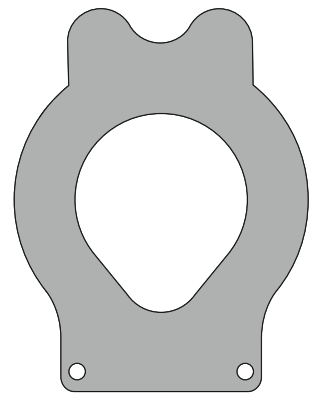
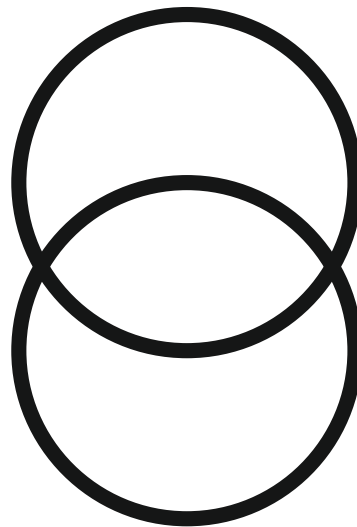
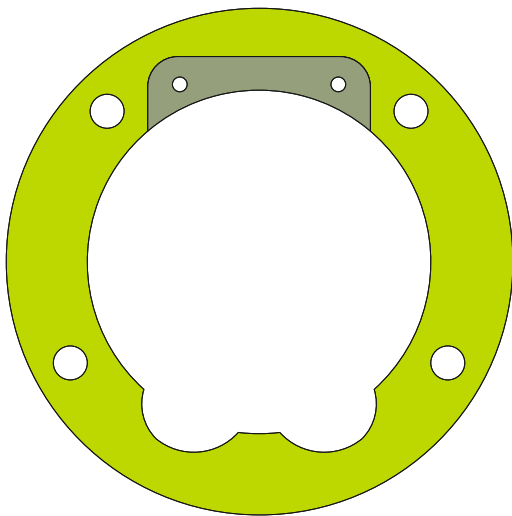

**346.080**

# DAF

# MOTSAN GASKET

Motor/Engine	Cm <sup>3</sup>	HP	Ø
F95 400 cc F95 380 cc			82 MM
DIESEL			



## DAF

F95 400 cc  
F95 380 cc

OEM	Description Of Goods	Mat.	Qty.	Reference
-----	----------------------	------	------	-----------

## AIR COMPRESSOR SET GASKET

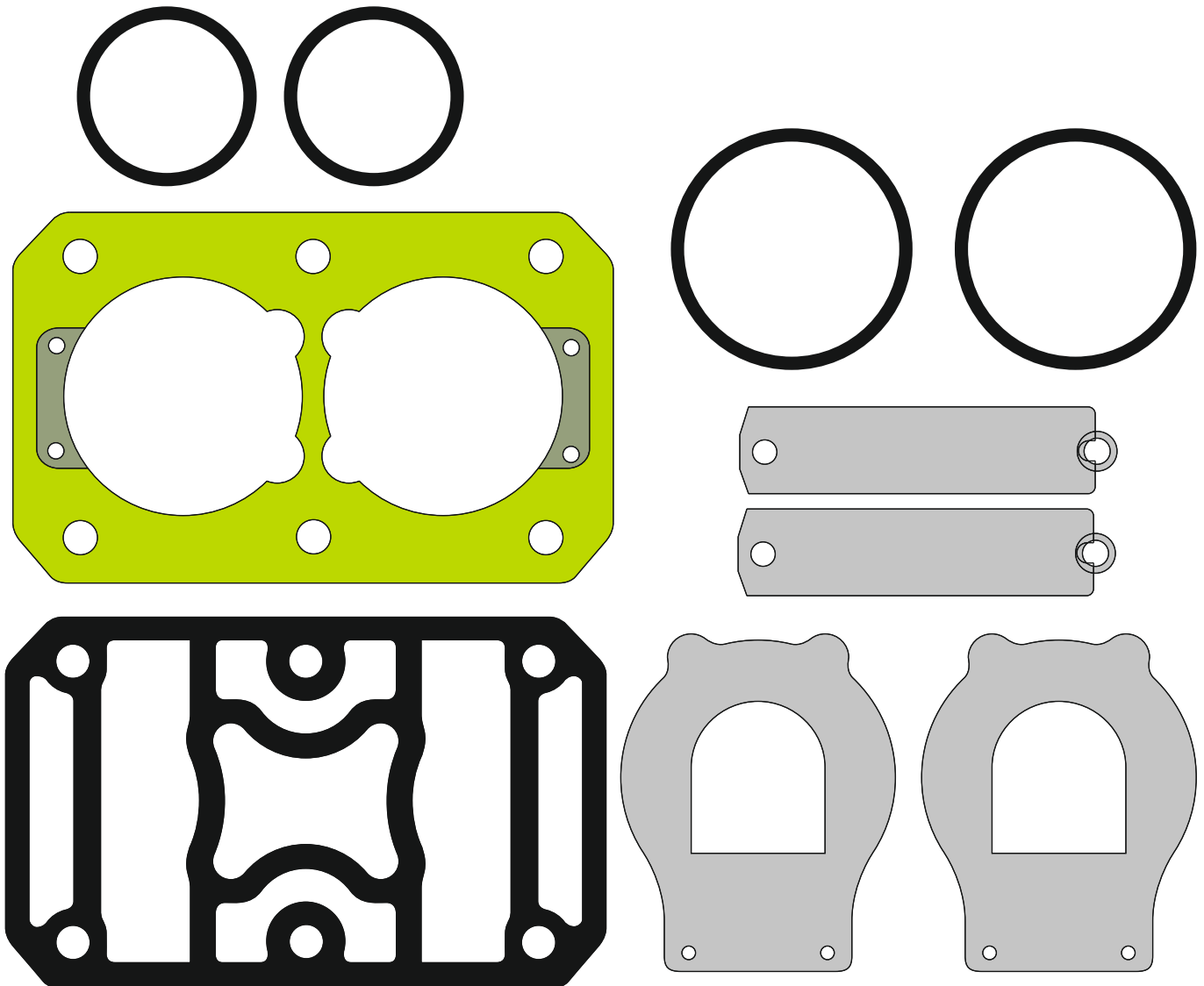

504.400

# RENAULT

# MOTSAN GASKET

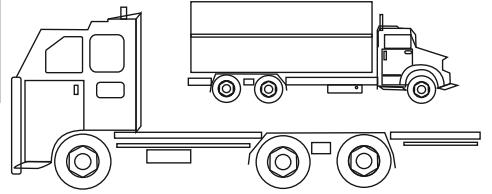

Motor/Engine	Cm <sup>3</sup>	HP	Ø
			MM
<b>DIESEL</b>			

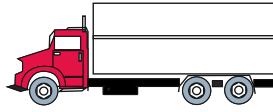

## RENAULT



## RENAULT TRUCKS

OEM	Description Of Goods	Mat.	Qty.	Reference
-----	----------------------	------	------	-----------

## AIR COMPRESSOR SET GASKET

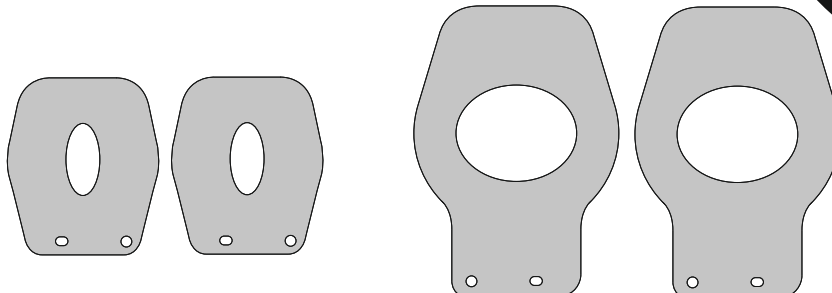
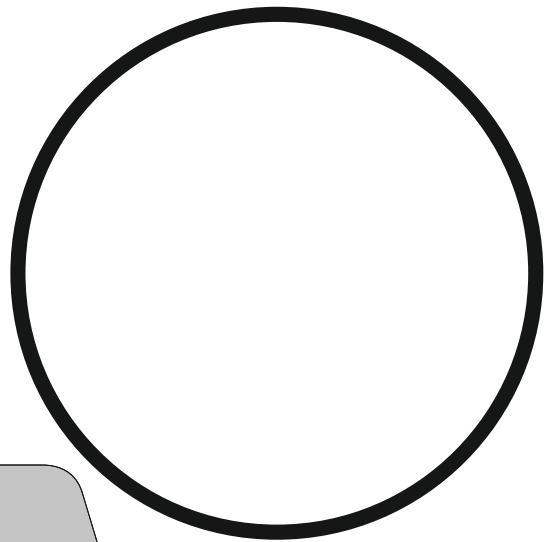
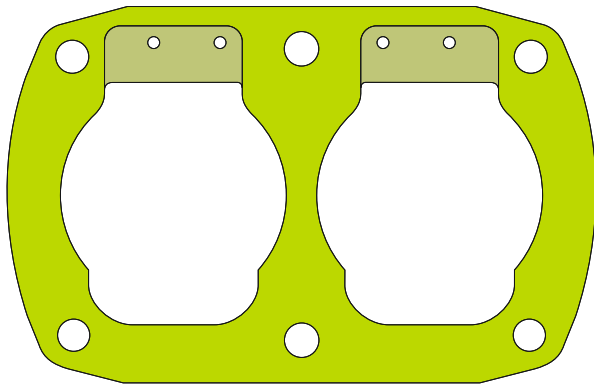
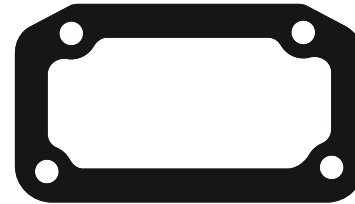
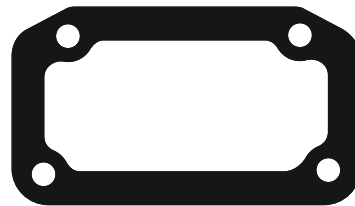
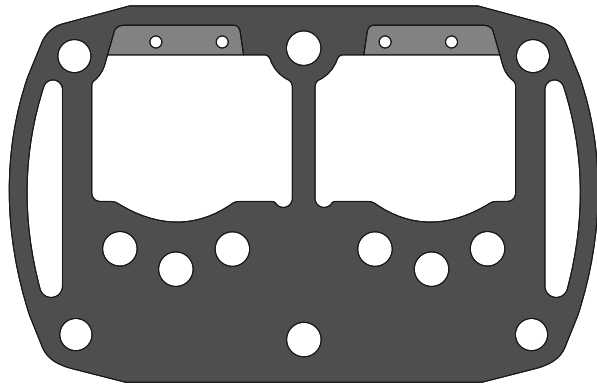

504.420



# MAN

# MOTSAN GASKET



Motor/Engine	Cm <sup>3</sup>	HP	Ø
26.280-281 2566-2866			MM
<b>DIESEL</b>			



OEM	Description Of Goods	Mat.	Qty.	Reference
-----	----------------------	------	------	-----------

## AIR COMPRESSOR SET GASKET

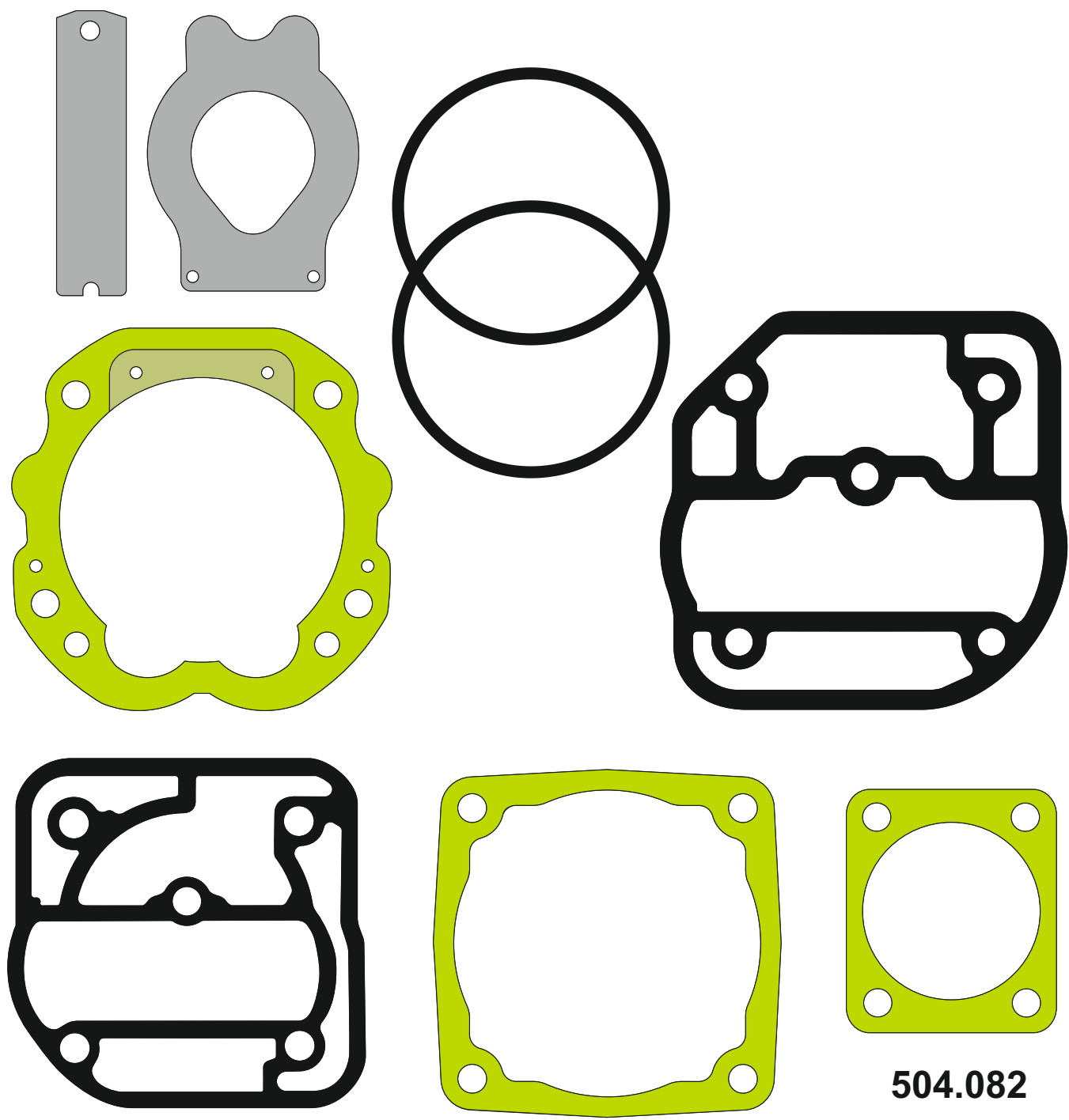

504.082

# SCANIA

# MOTSAN GASKET

Motor/Engine	Cm <sup>3</sup>	HP	Ø
LP 4812 440 CC			MM
<b>DIESEL</b>			



**SCANIA**  
LP 4812  
440 CC

OEM	Description Of Goods	Mat.	Qty.
-----	----------------------	------	------



# SCANIA

## AIR COMPRESSOR SET GASKET

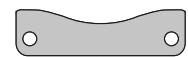
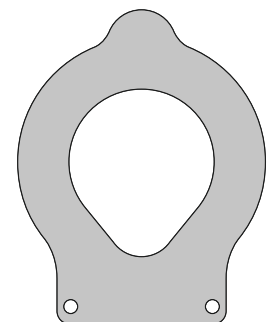
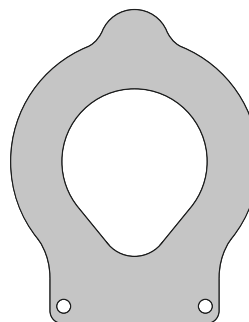
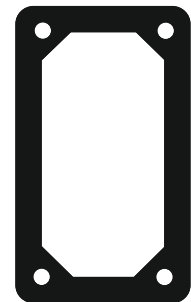
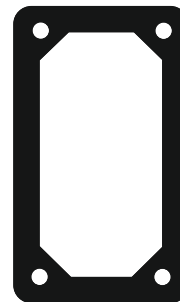
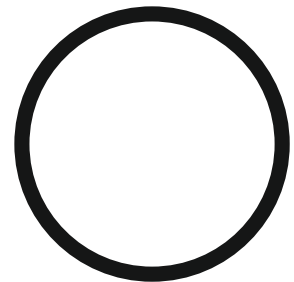
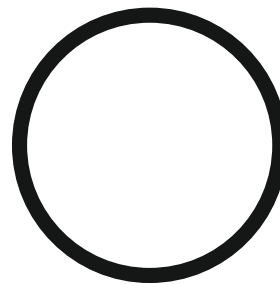
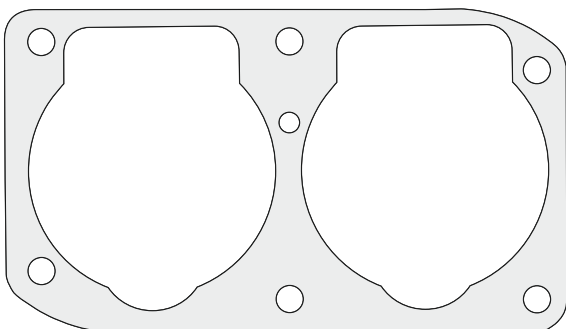
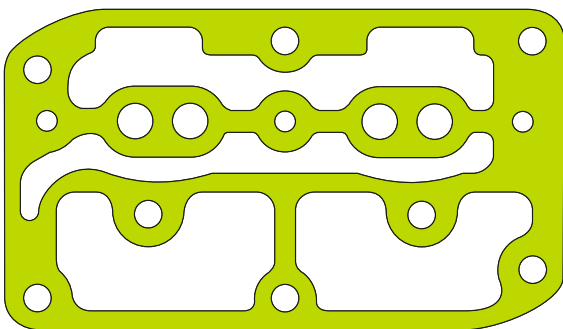
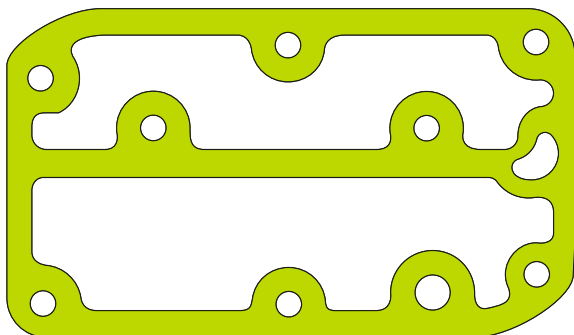

**504.812**

# VOLVO

# MOTSAN GASKET



**VOLVO**  
LP 4850

**VOLVO**

Motor/Engine	Cm <sup>3</sup>	HP	Ø
LP 4850			MM

DIESEL

**VOLVO**

OEM	Description Of Goods	Mat.	Qty.
-----	----------------------	------	------

## AIR COMPRESSOR SET GASKET

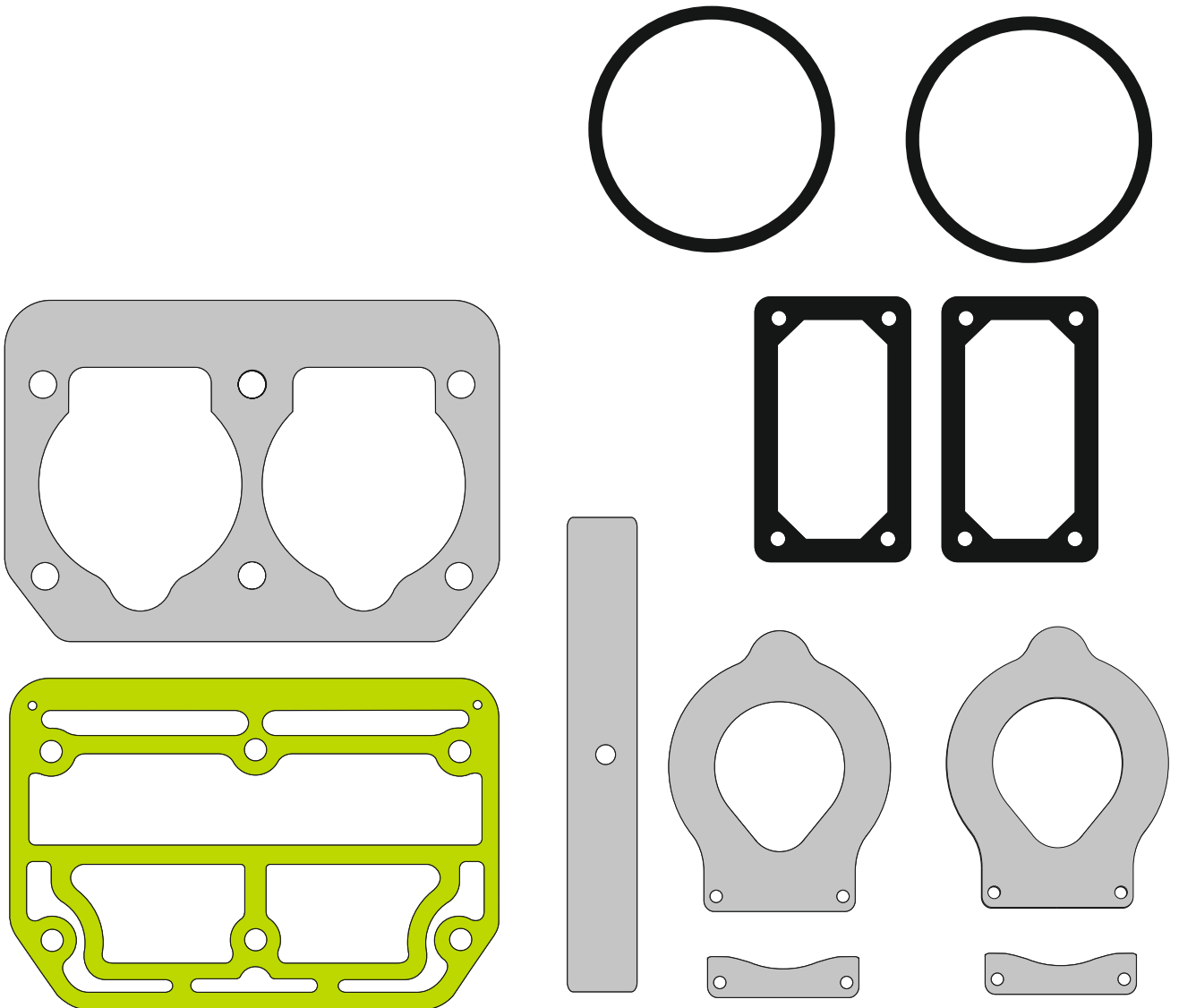

**504.850**

MERCEDES BENZ

# MOTSAN GASKET

Motor/Engine	Cm <sup>3</sup>	HP	Ø
OM 366-25/17			MM
<b>DIESEL</b>			



MERCEDES BENZ

OM 366-25/17

OEM	Description Of Goods	Mat.	Qty.
-----	----------------------	------	------



## AIR COMPRESSOR SET GASKET

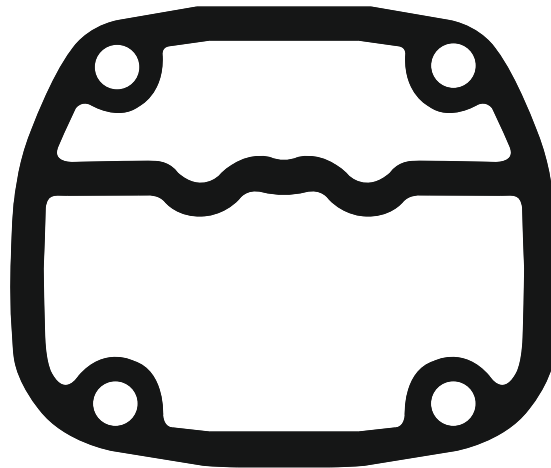
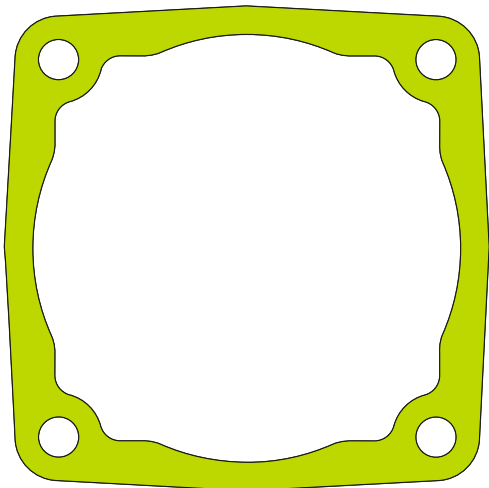
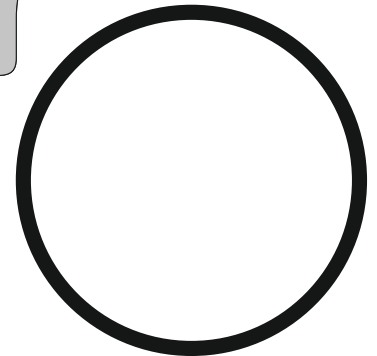
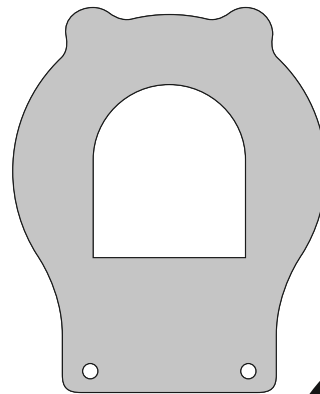
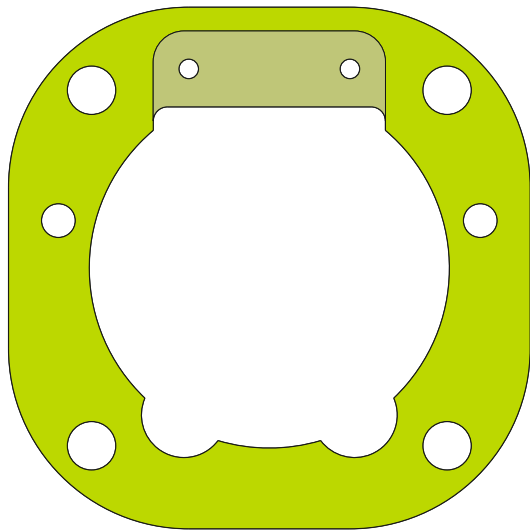

504.105

# MOTSAN GASKET

for

# CAT

# CATERPILLAR



[info@motsanconta.com](mailto:info@motsanconta.com)  
[www.motsanconta.com](http://www.motsanconta.com)